

Choinki / Christmas trees

Designed by Elżbieta Udziela 2005
Diagrammed by Elżbieta Udziela & Rafał Sabat 2009
e-mail: ela.udziela@gmail.com
www.origamiart.pl

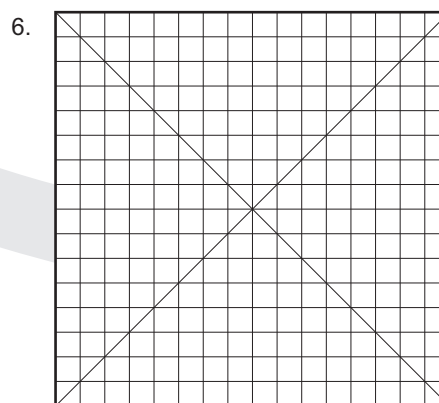

Choinka

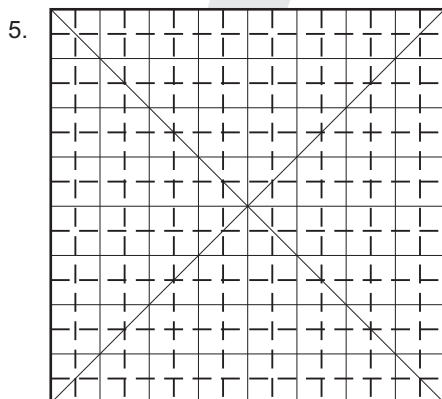
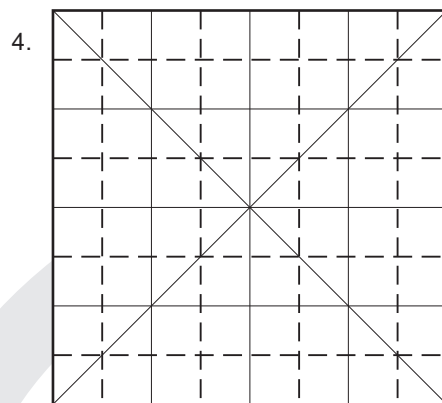
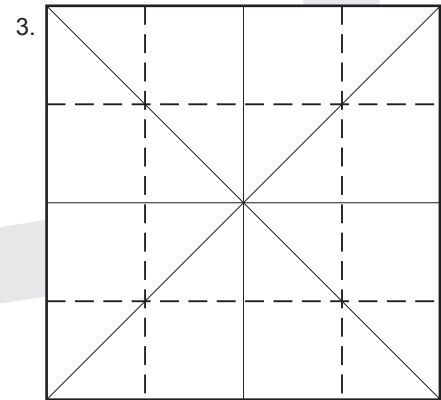
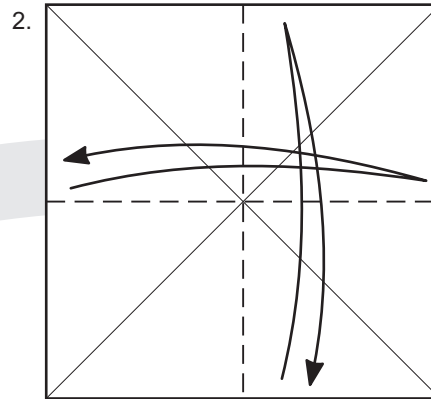
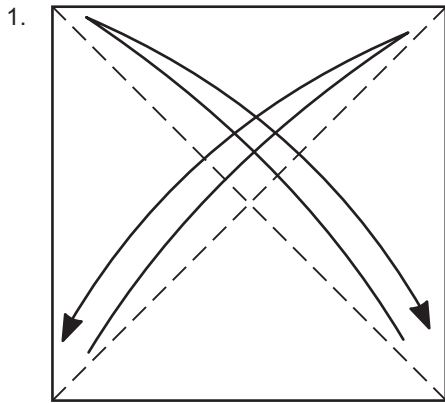

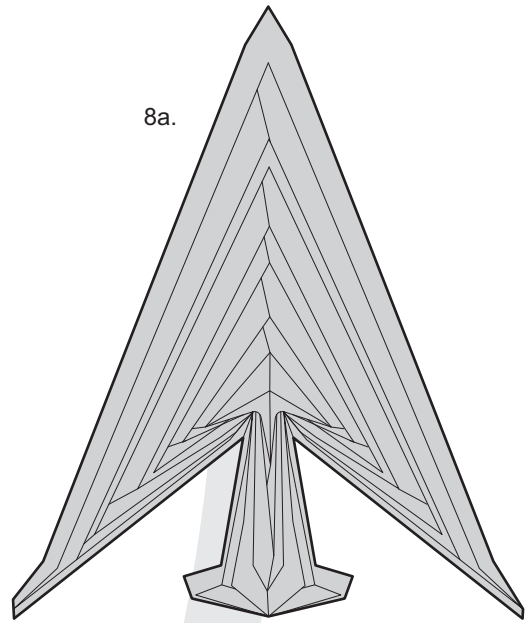
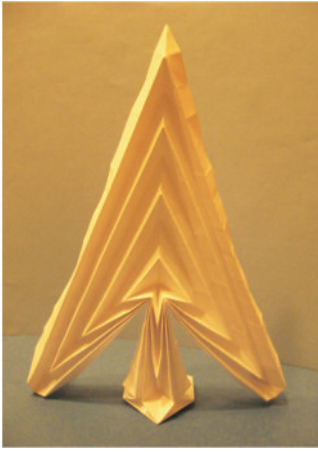

7a. Składanie siatki rozpoczynamy od wierzchołków kwadratu.
Najpierw modelujemy wierzchołek choinki, potem boki,
na końcu pień.

- zgięcia wypukłe
- zgięcia wklęsłe

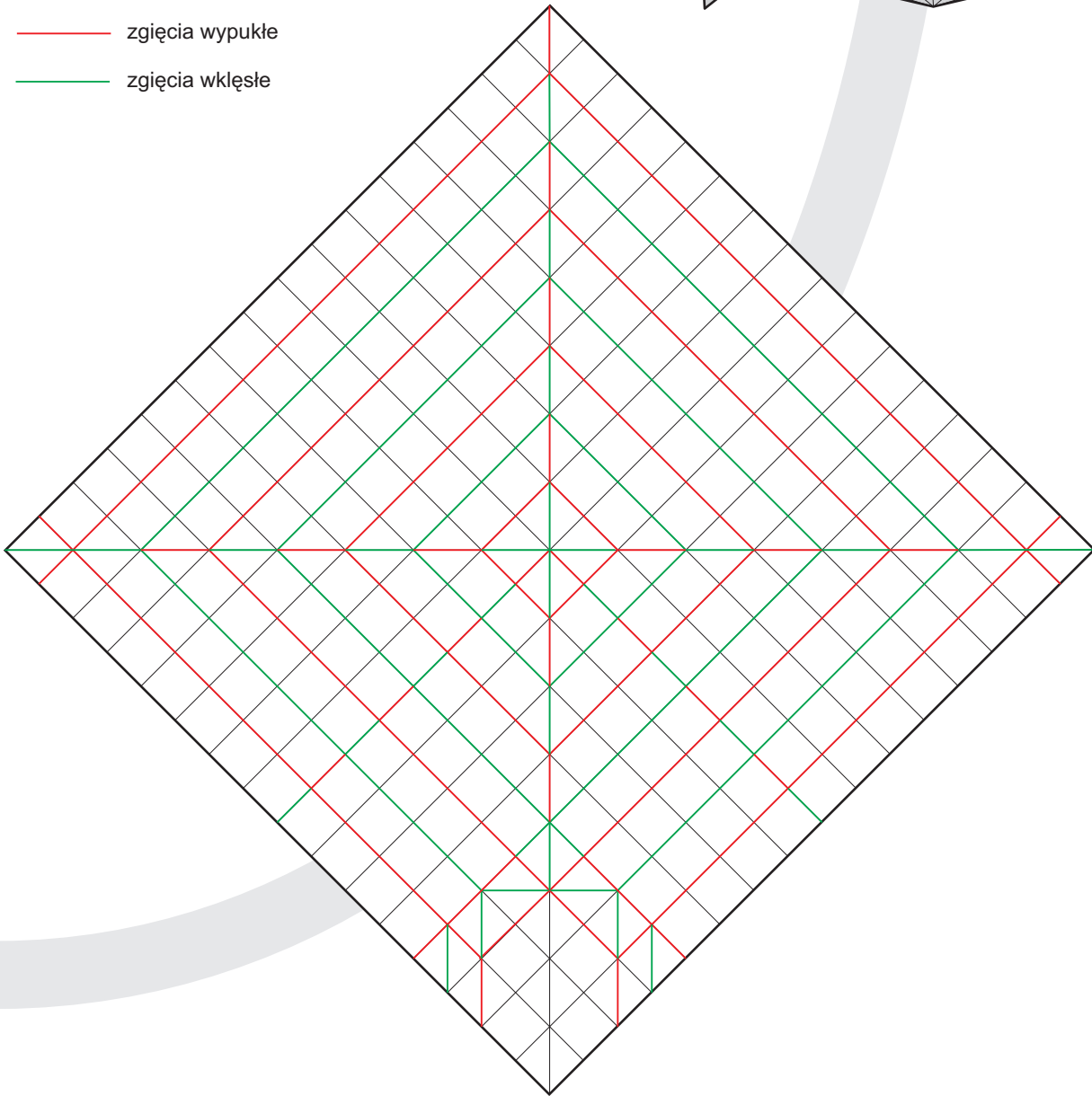

Choinka – wersja uproszczona

Wykonujemy kroki 1-4 ze strony 1



1.

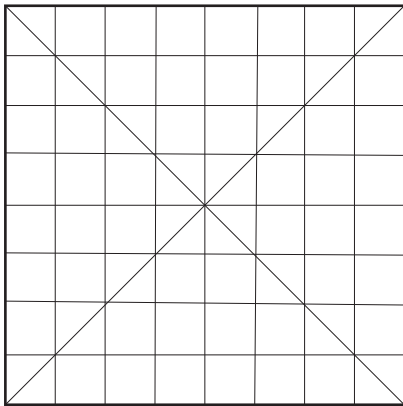

2.

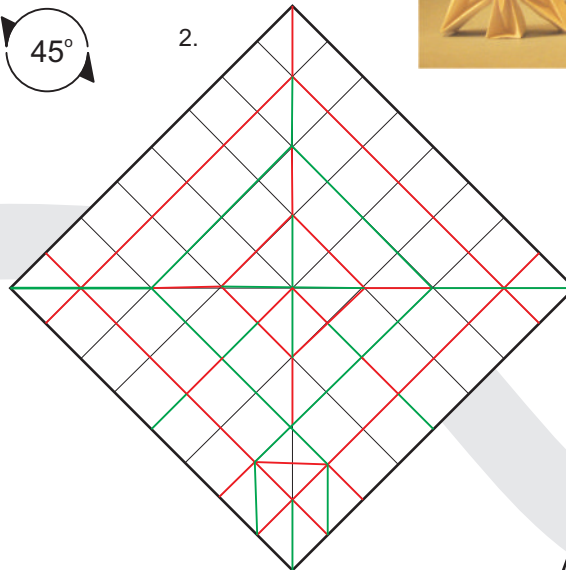

3.

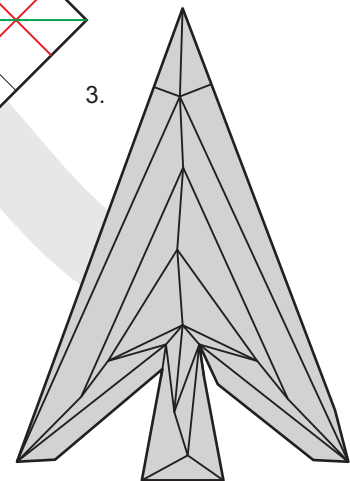

Gwiazdka z ośmiokąta

Choinkę można ozdobić gwiazdką.

1. Gwiazdkę wykonujemy z kwadratu, będącego czwartą częścią kwadratu, z którego złożyliśmy choinkę.

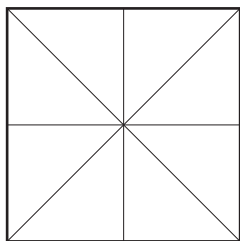

2.

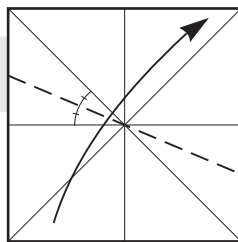

3.

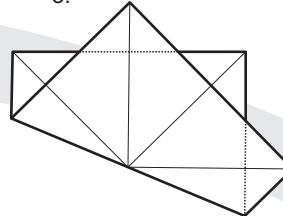

4. Odcinamy wystające trójkąty równoramienne i rozkładamy..

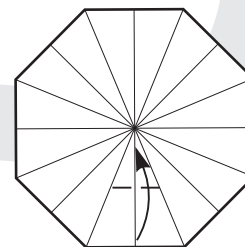
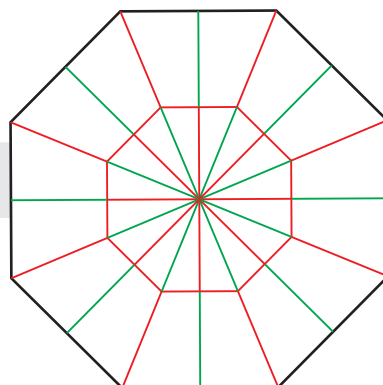
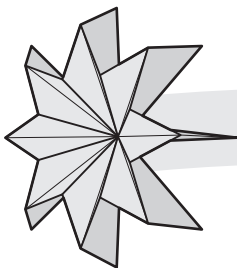
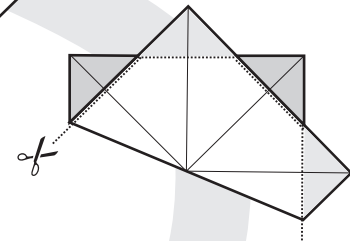

7. Gotowa gwiazdka.

Gwiazdkę mocujemy na wierzchołku choinki klejem. Przed doklejeniem gwiazdki wierzchołek choinki zaginamy tak samo jak boki.

6. Modelowanie gwiazdki rozpoczynamy od wierzchołków ośmiokąta.

5. Zaznaczamy wszystkie brakujące osie symetrii.

Choinka z gwiazdką

Wykonujemy kroki 1-6 ze strony 1

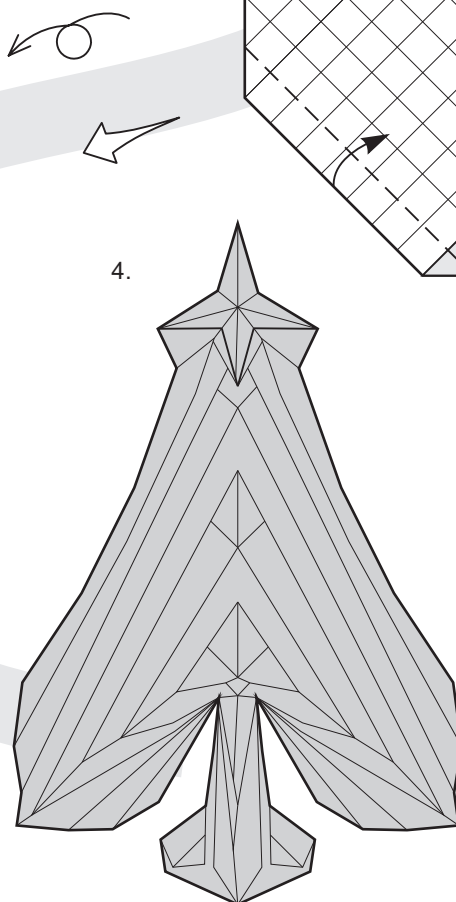
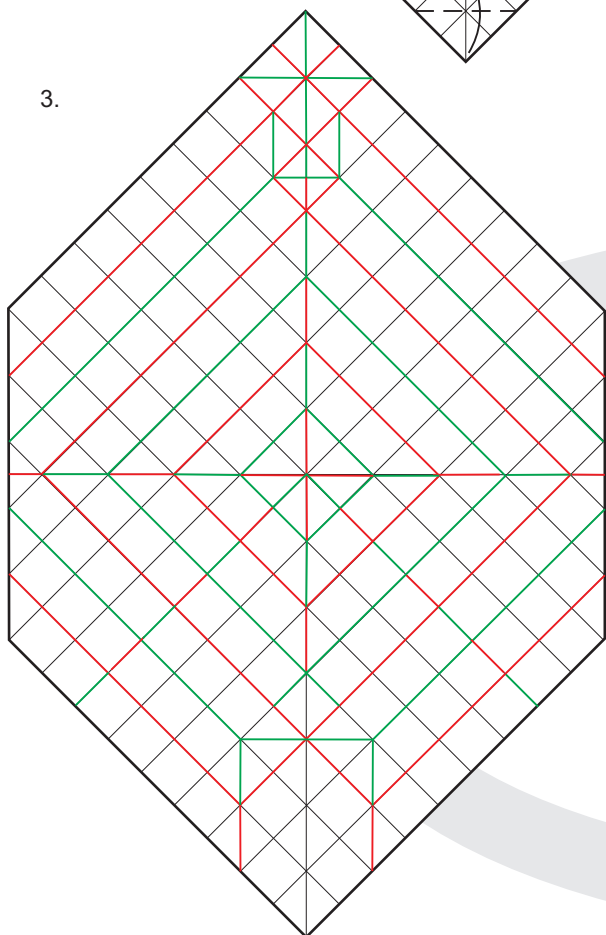
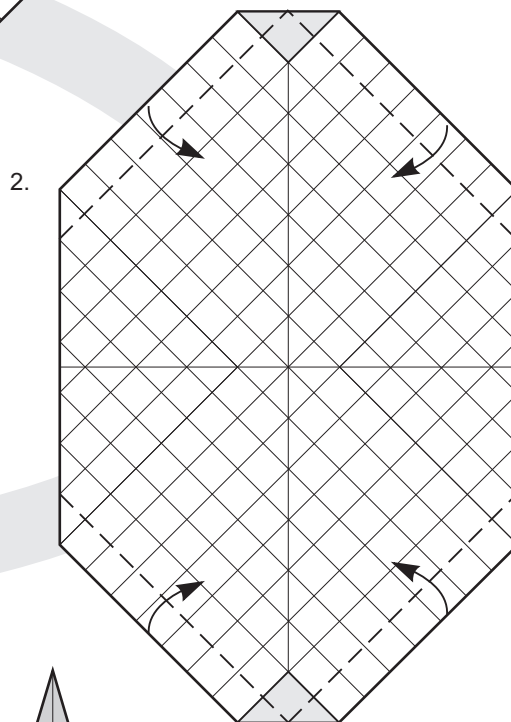
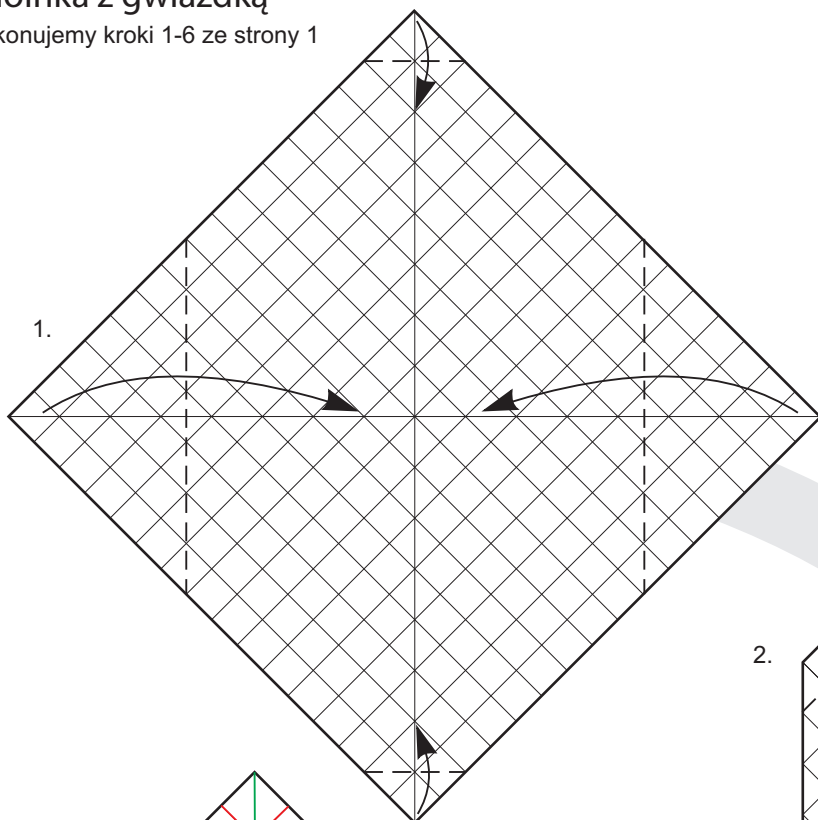

— zgięcia wypukłe

— zgięcia wklęsłe