

ORZEK PRZEDNI

TOMASZ SIWAK

$\varnothing a = 20 \div 30 \text{ cm}$

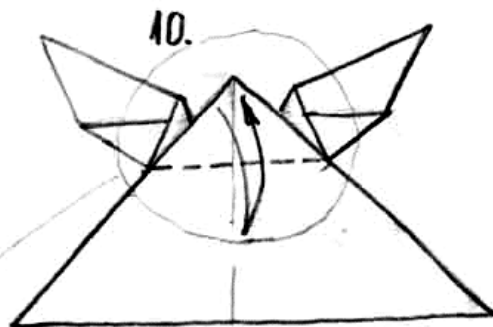
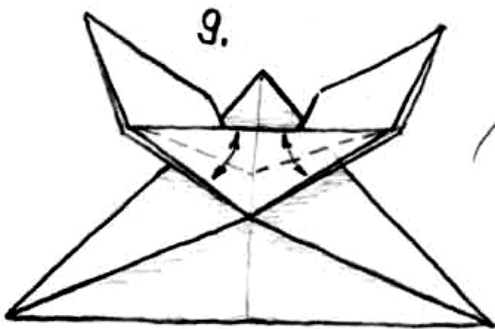
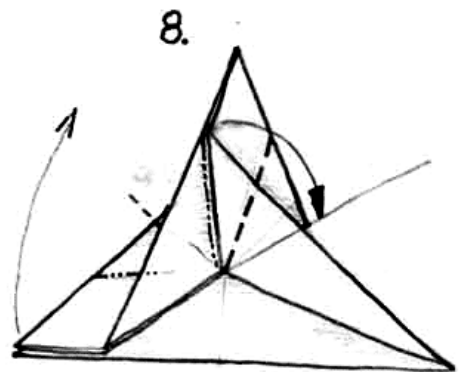
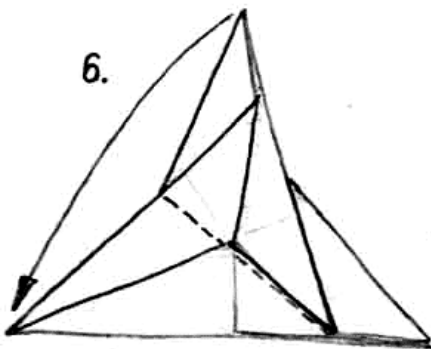
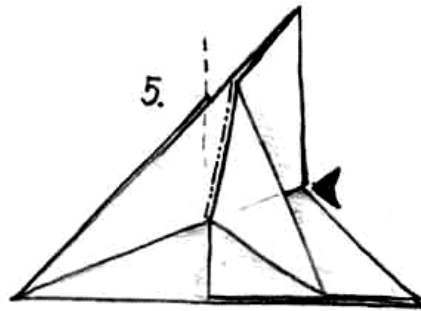
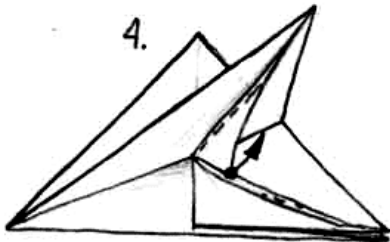
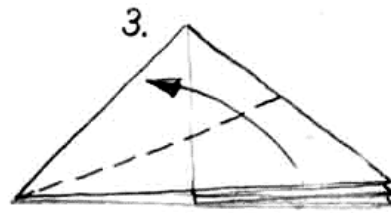
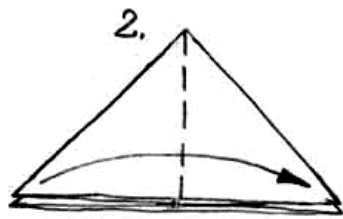
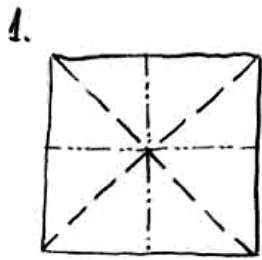

ODEGNIJ I POWTÓRZ Z DRUGIEGO BOKU

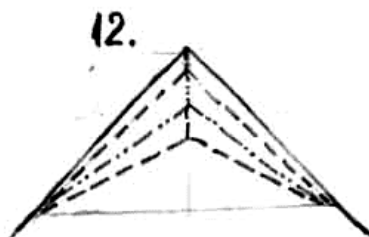

Origami
Papeteria

Tomasz Siwak

13.

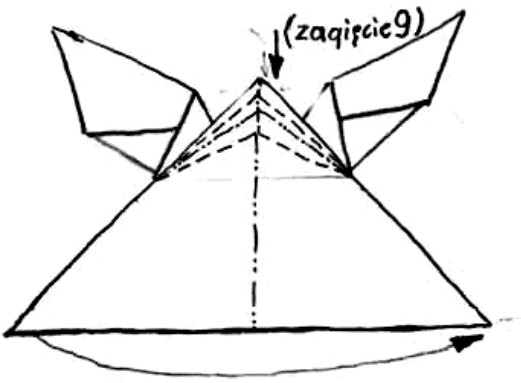

14.

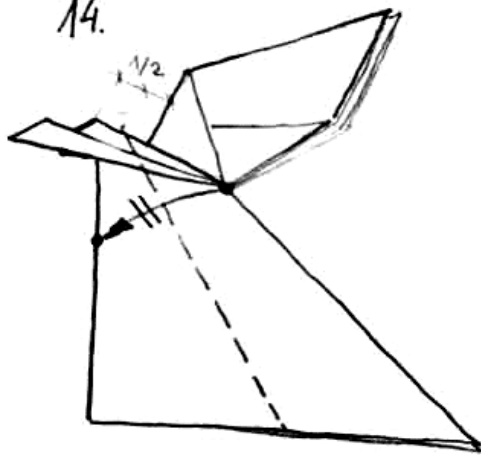

15.

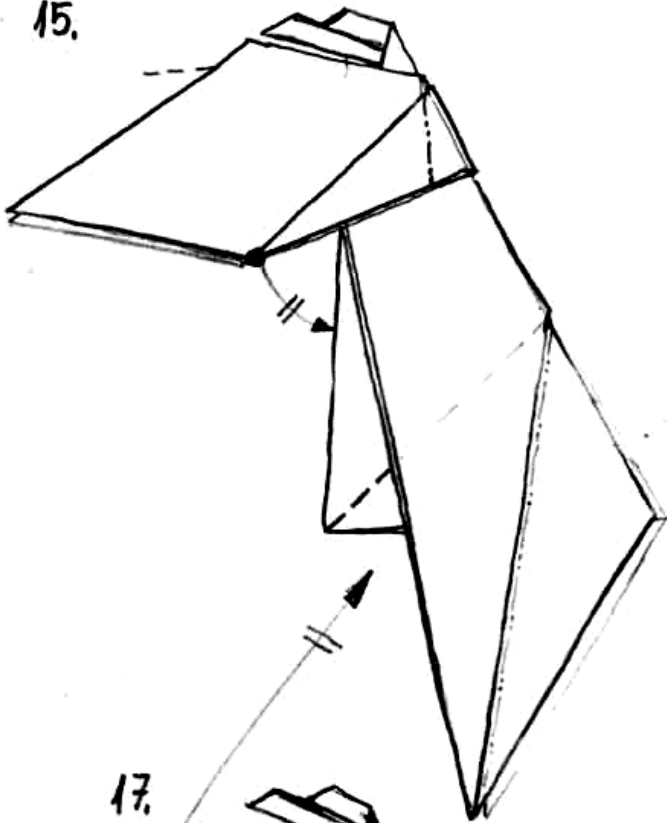

16.

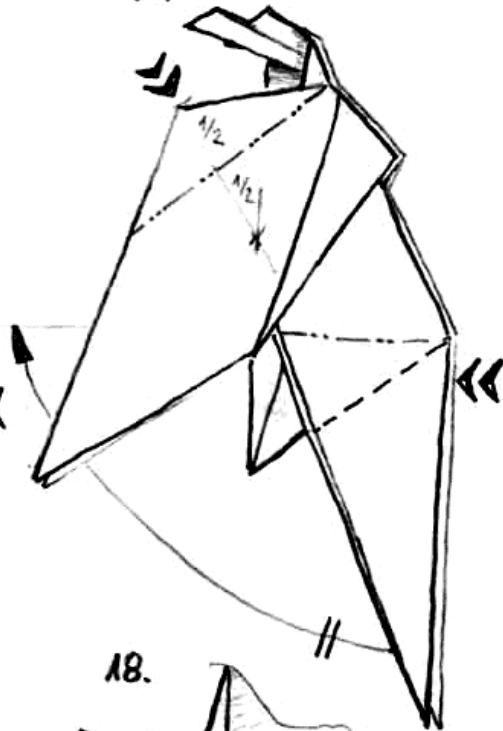

17.

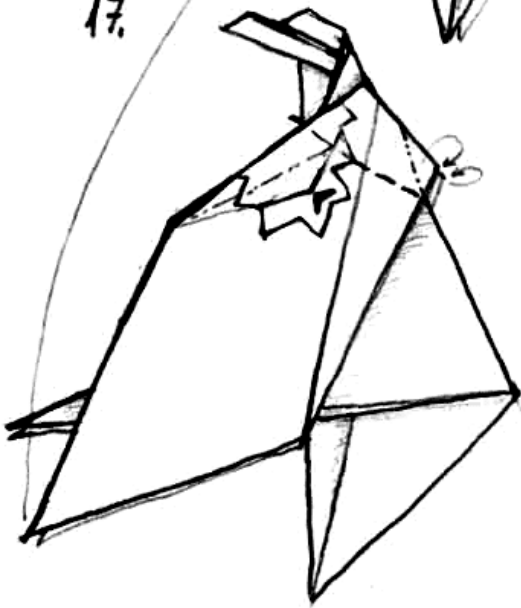

18.

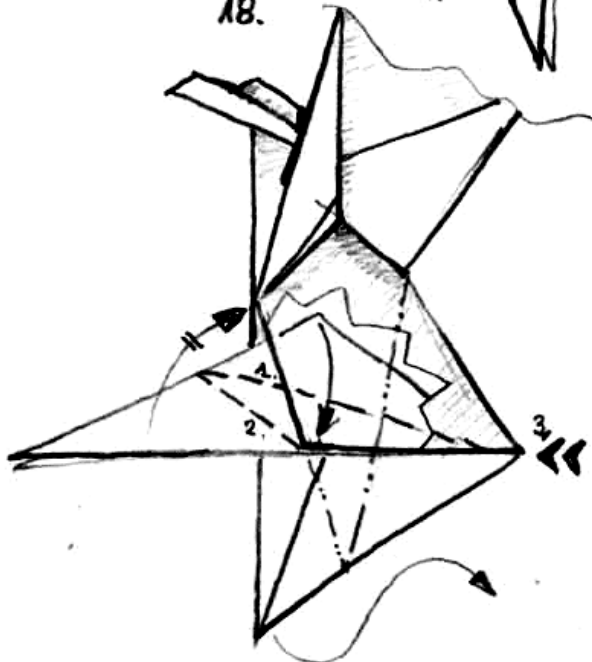

19.

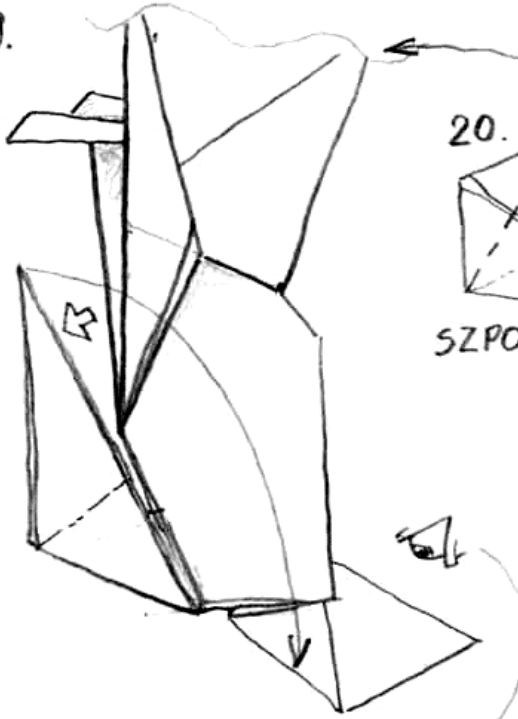

20.



SZPONY.

21.

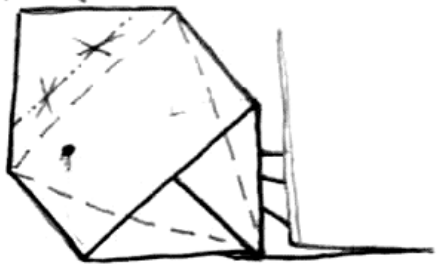

22.

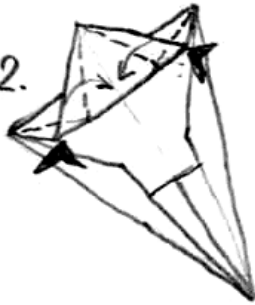

23.

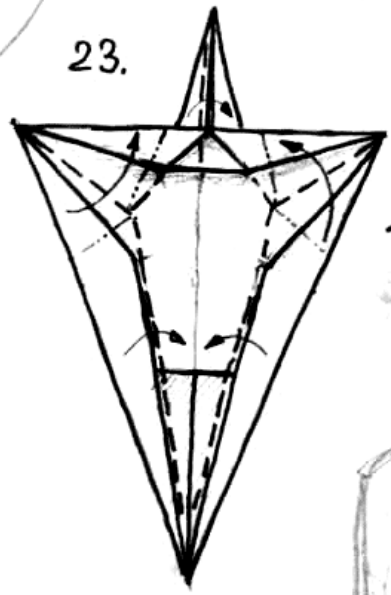

WYMODELOWAĆ SZPONY

24.



LEKKO ROZCHYLIĆ I WYMODELOWAĆ PIÓRA OGONA

25.

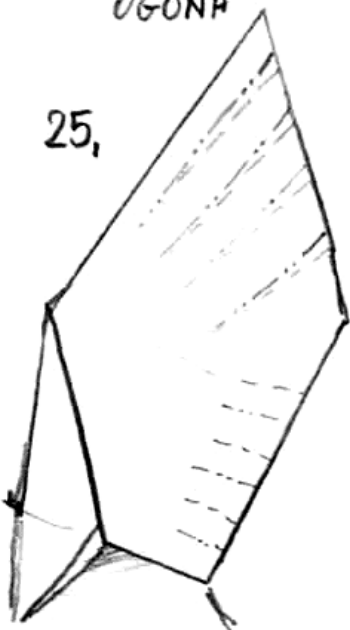

Tomasz Siwałk IV'05